

INDIVIDUAL ROOM TABLE SET UP

- PAGE 1 -

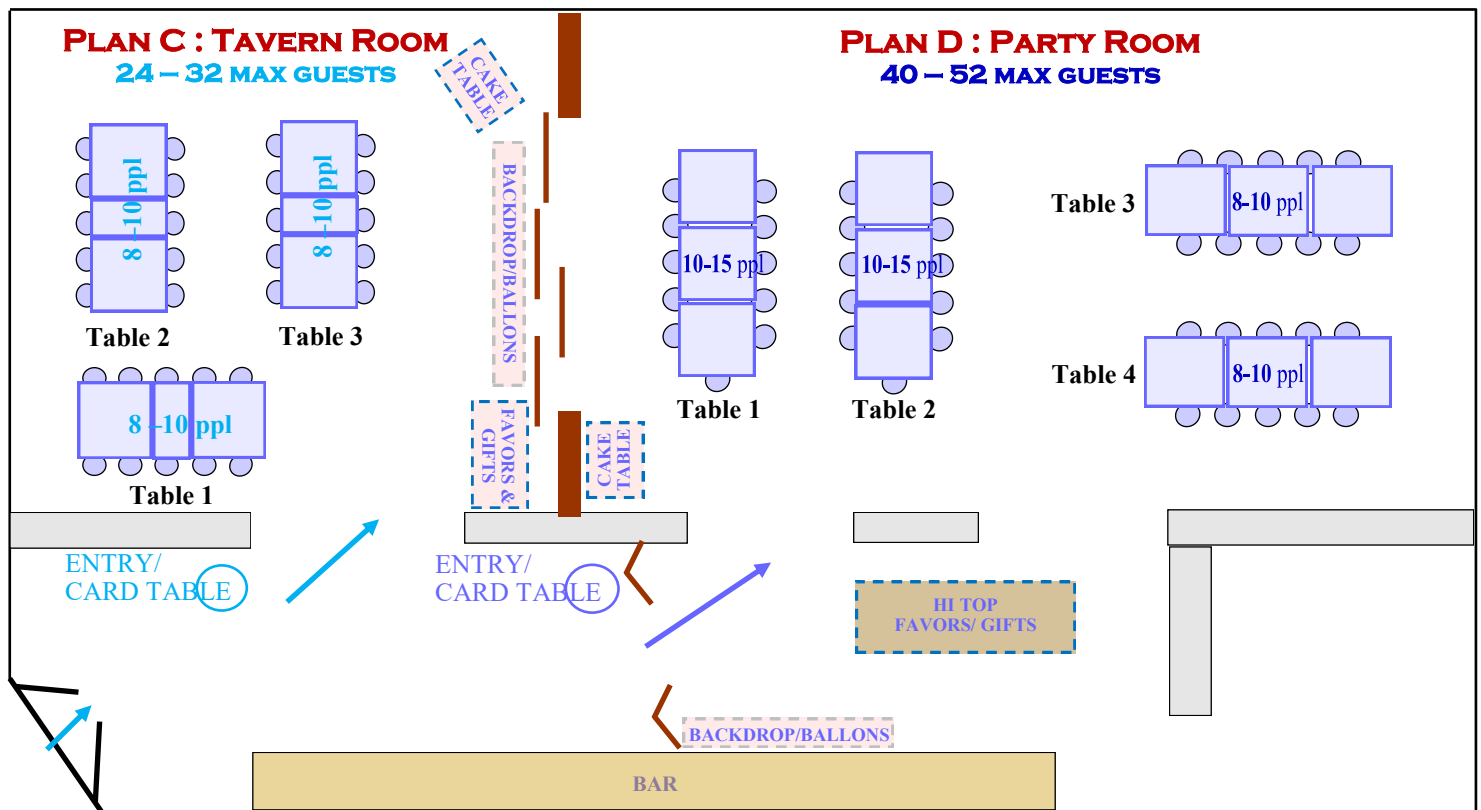
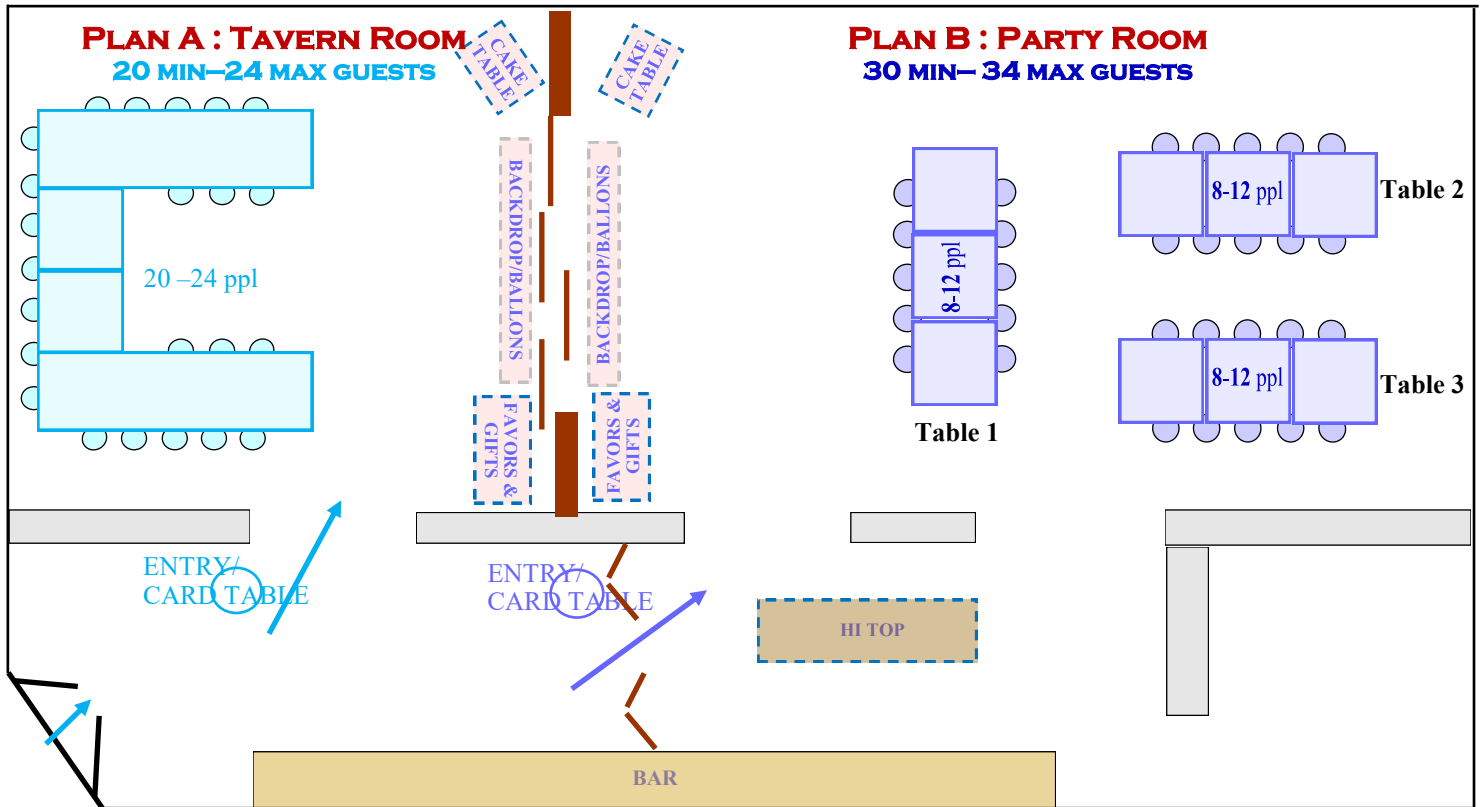

COMBINED PARTY & GARDEN ROOM

COMBINED 55 MIN – 60 GUESTS

- PAGE 2 -

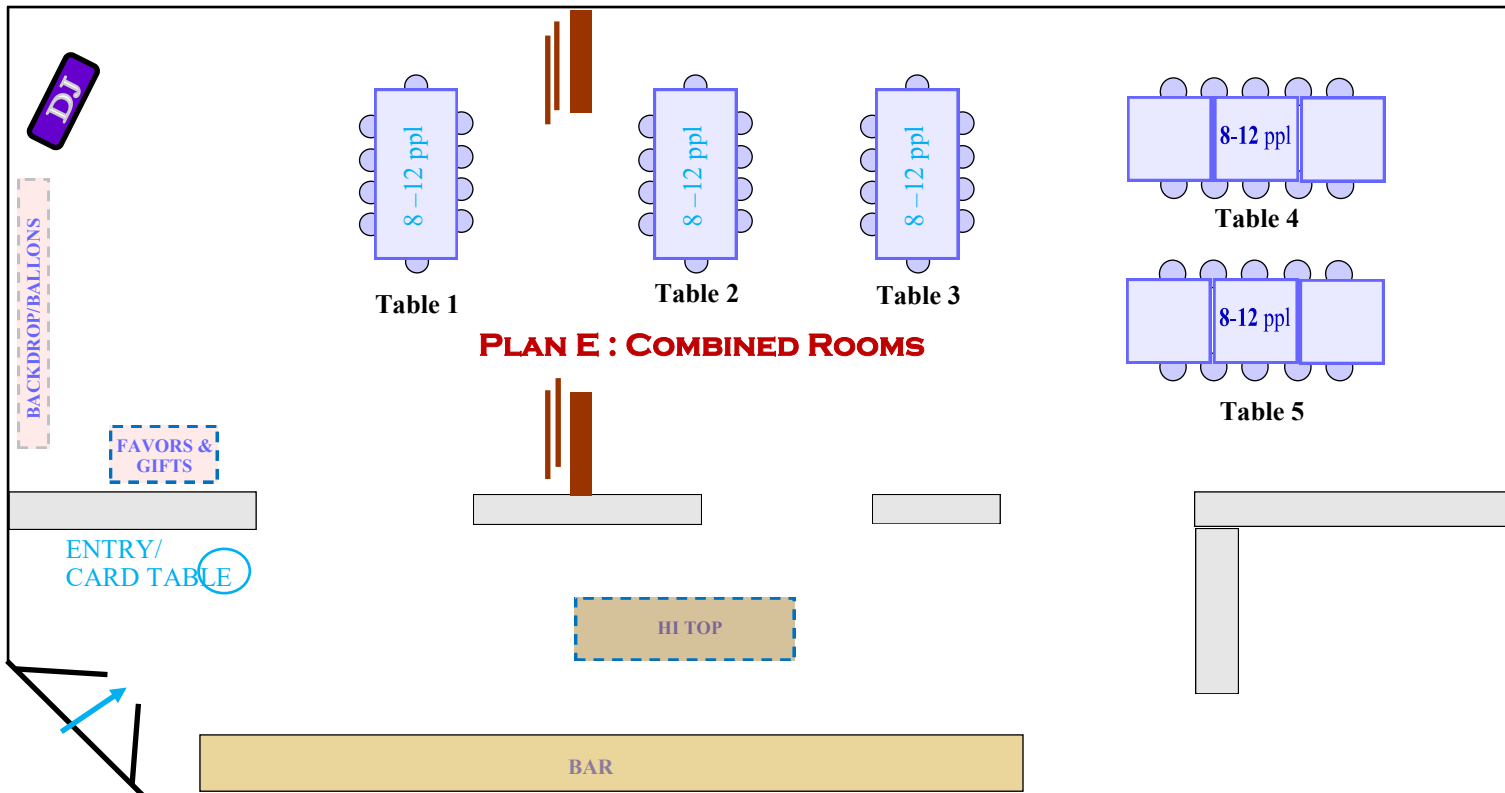

COMBINED PARTY & GARDEN ROOM

COMBINED 55 MIN – 90 MAX

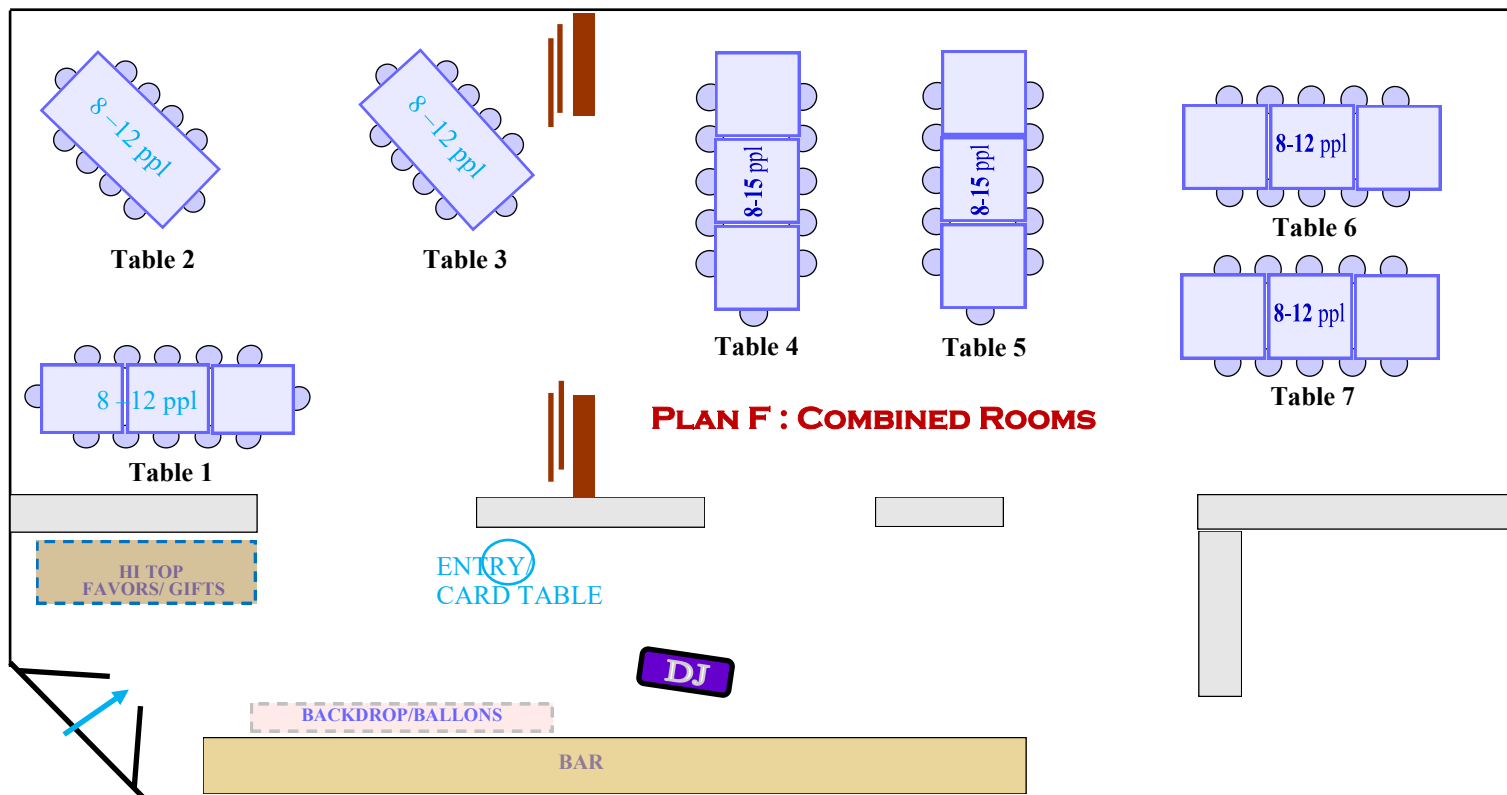

MAIN DINING ROOM

AVAILABLE SAT FROM 12 TO 2PM START TIMES ONLY

AVAILABLE SUNDAY ALL DAY

SEMI PRIVATE

- PAGE 3 -

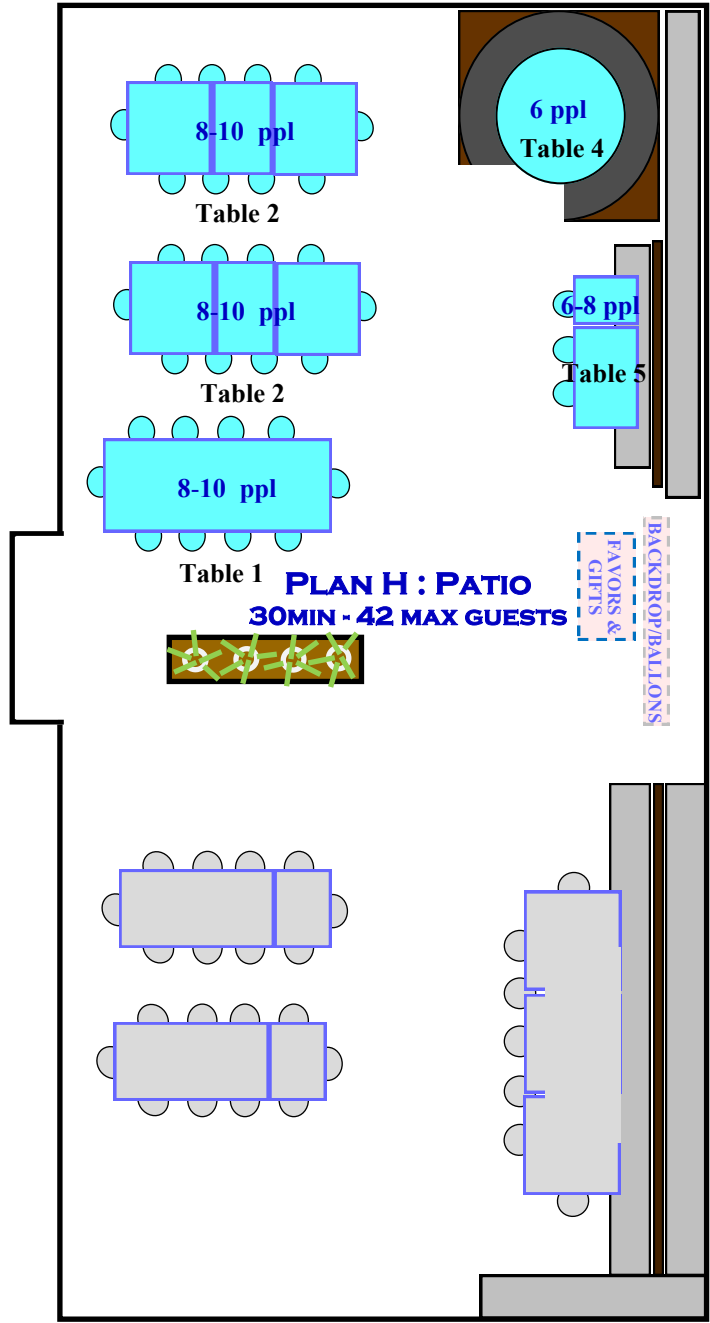

MAIN DINING ROOM

AVAILABLE SAT & SUN (NOON TO 2PM START TIMES ONLY)

PRIVATE

- PAGE 4 -

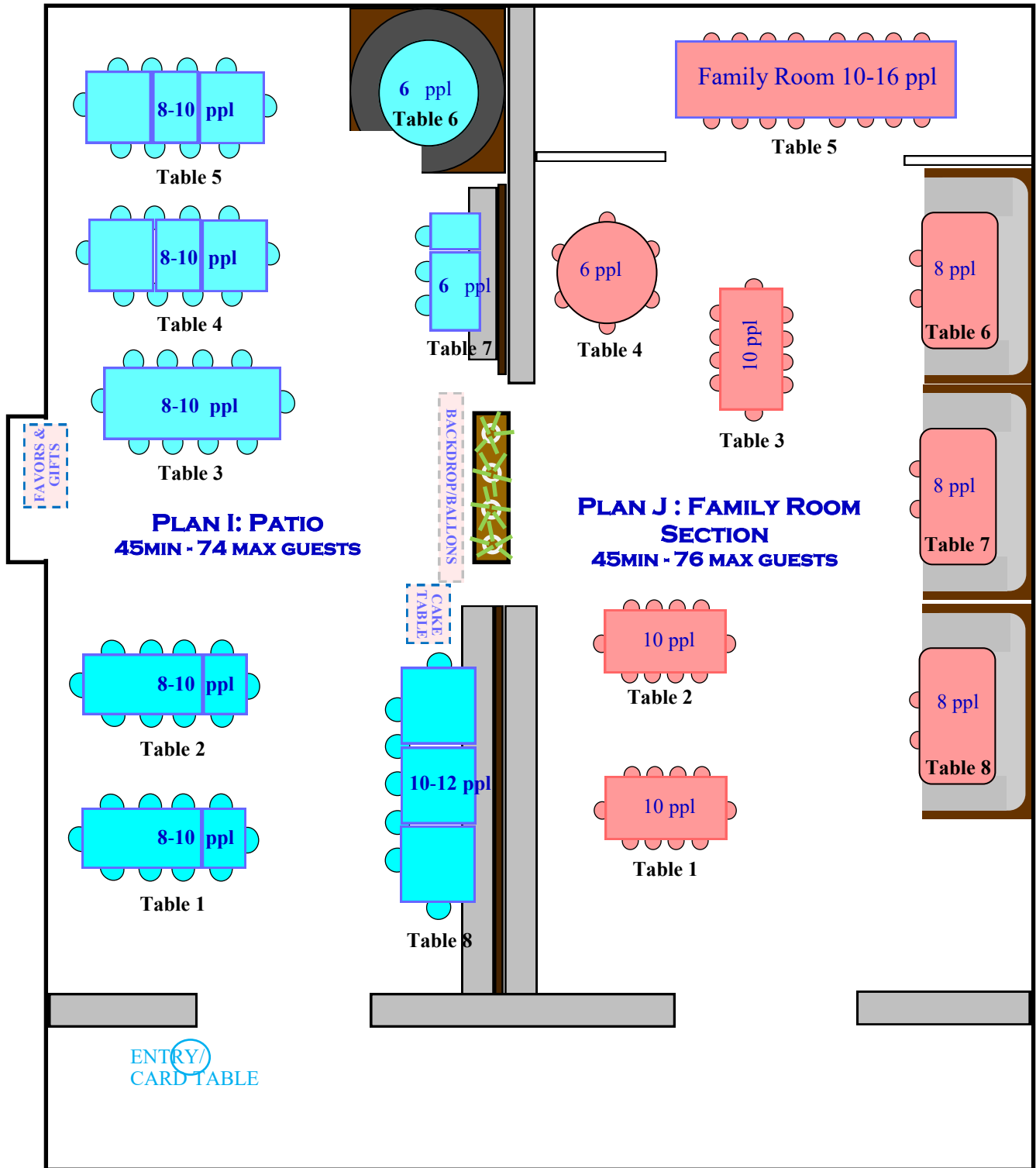

COMBINED 90 MIN - 150 MAX

SEMINARS - LONG TABLES

COMBINED 40 MIN REQUIRED – 36 TO 54 GUESTS

- PAGE 5 -

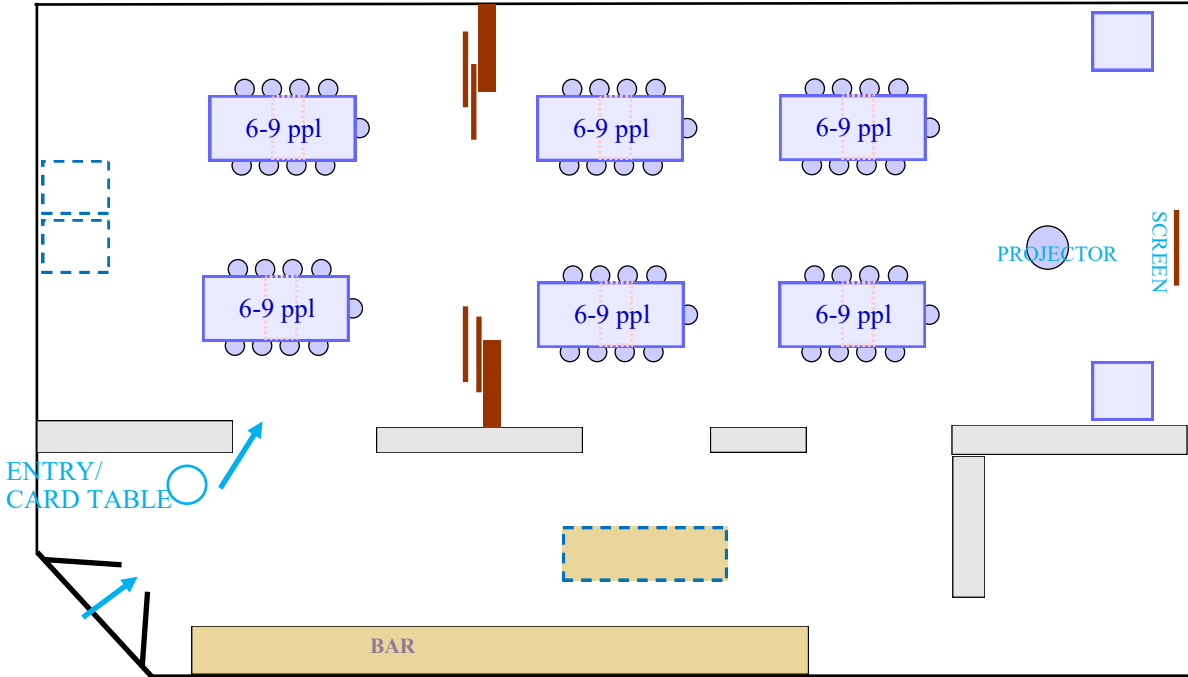

SEMINARS - ANGLED TABLES

COMBINED 40 MIN REQUIRED – 36 TO 48 GUESTS
(WHOLE LIFE CAPITAL SET UP)

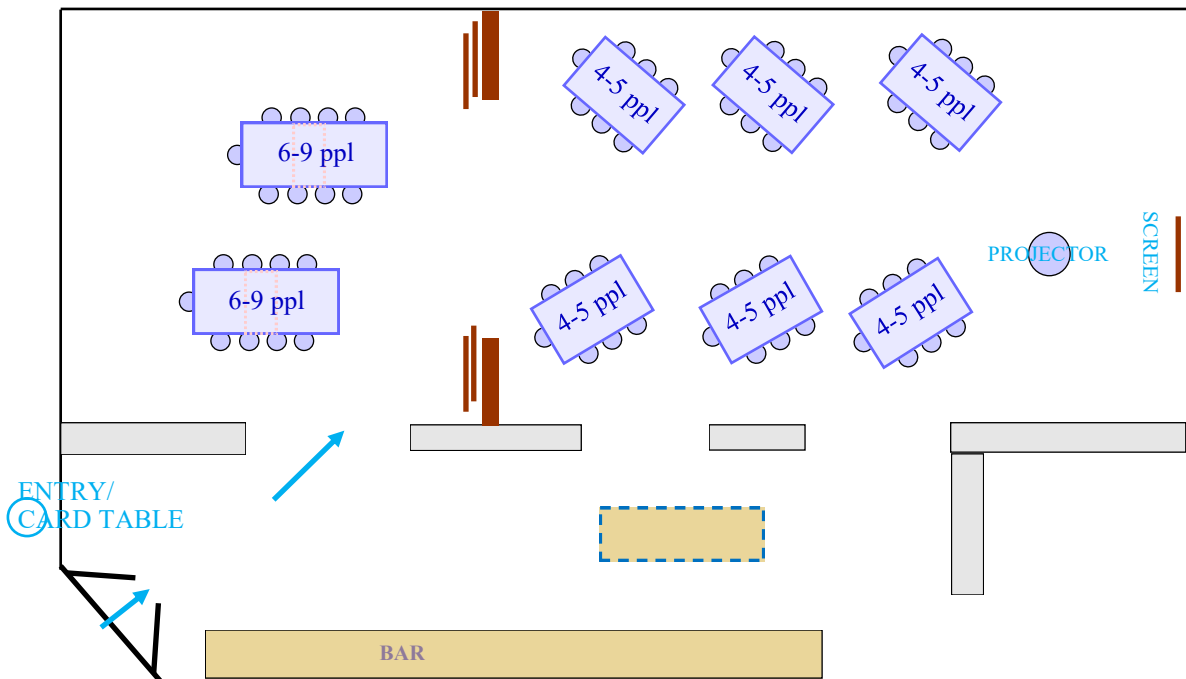

SEMINARS - SEPERATE

COMBINED 40 MIN REQUIRED – 36 TO 56 GUESTS

- PAGE 6 -

